

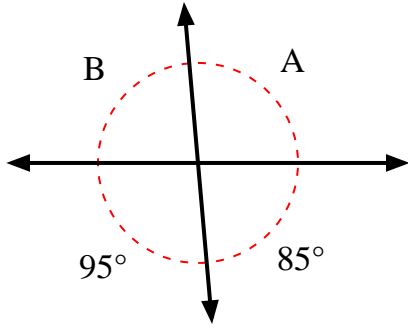

Trova il valore dell'angolo 'A' e dell'angolo 'B'.

1)



2)

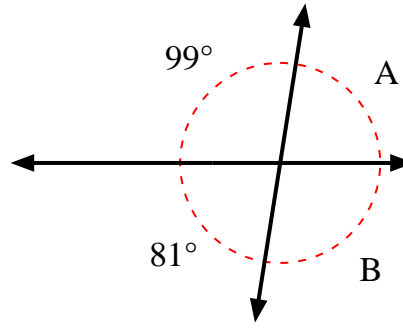

3)

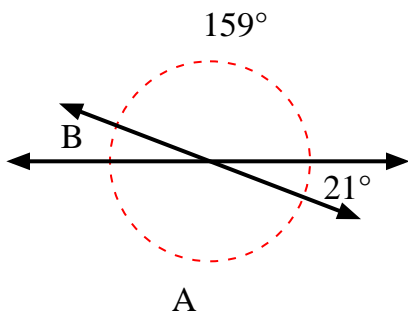

4)

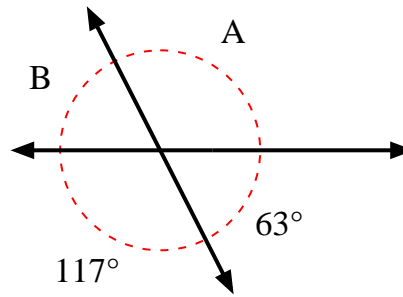

5)

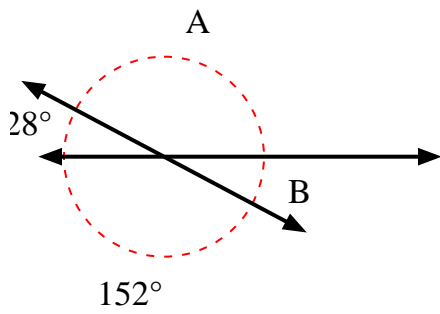

6)

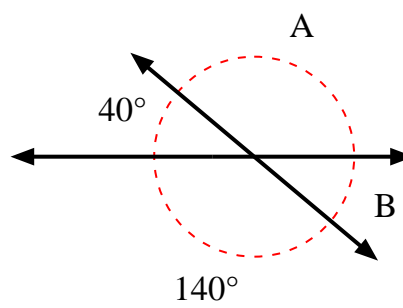

7)

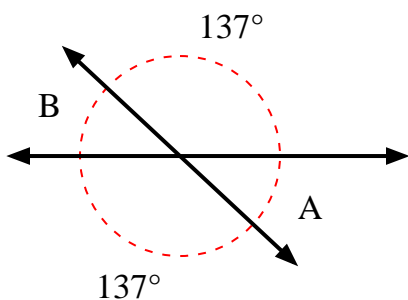

8)

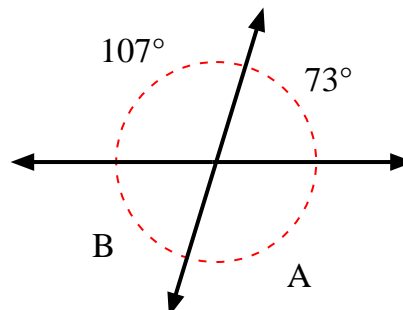
**Risposte**

1. _____
2. _____
3. _____
4. _____
5. _____
6. _____
7. _____
8. _____



Trova il valore dell'angolo 'A' e dell'angolo 'B'.

1)

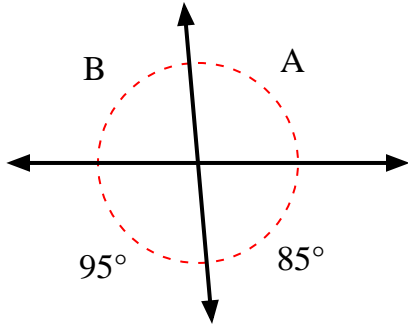

2)

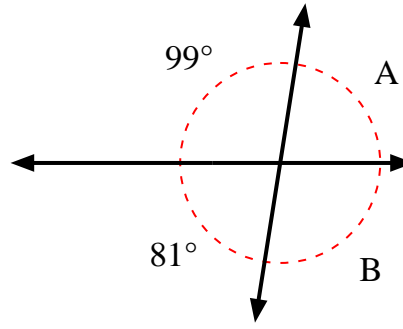

3)

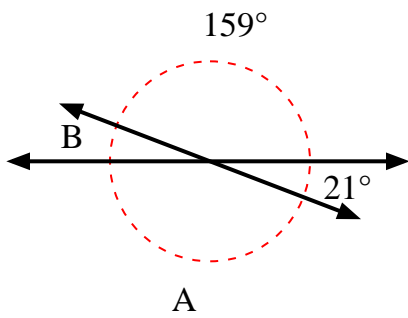

4)

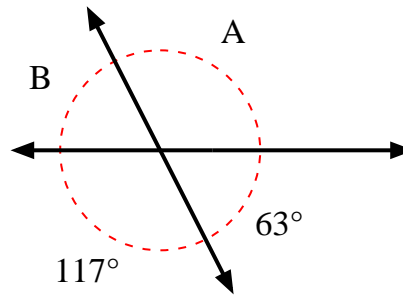

5)

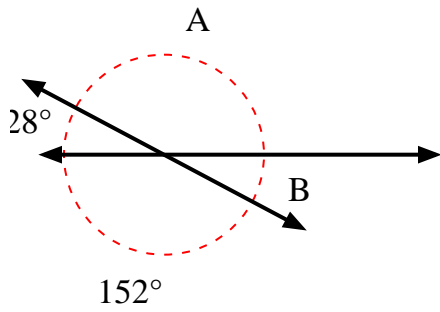

6)

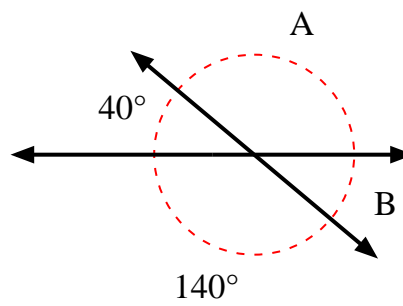

7)

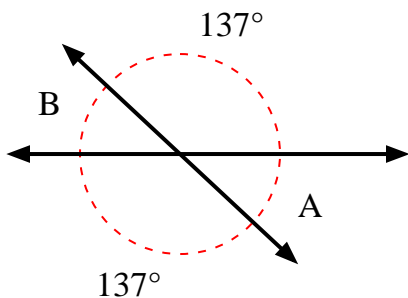

8)

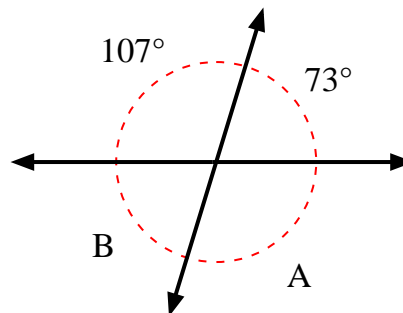
**Risposte**

1.	95°	85°
2.	81°	99°
3.	159°	21°
4.	117°	63°
5.	152°	28°
6.	140°	40°
7.	43°	43°
8.	107°	73°