

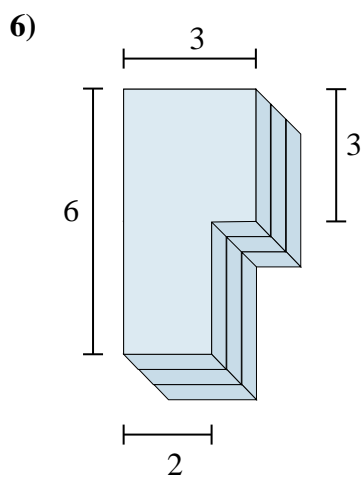

Trova il volume totale di ogni figura.

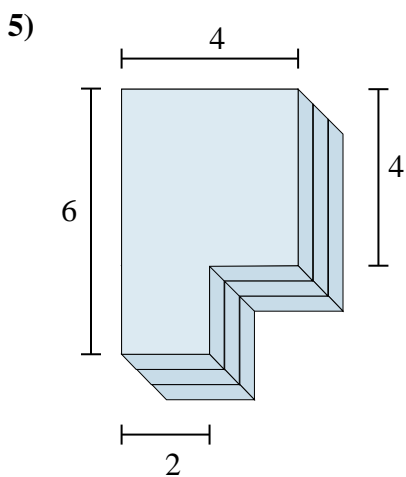
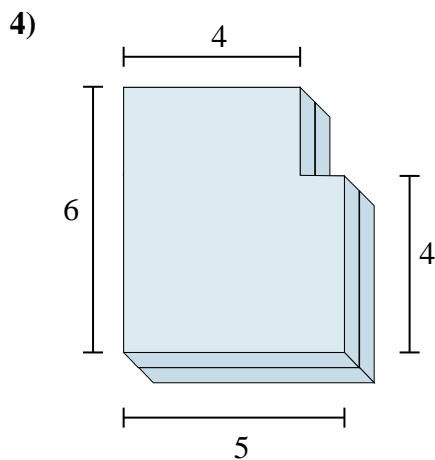
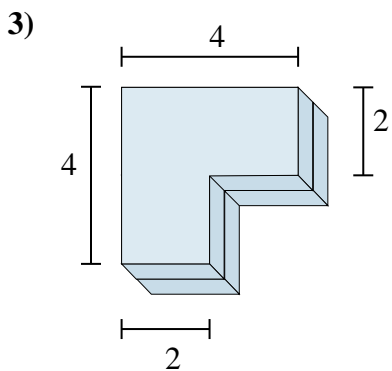
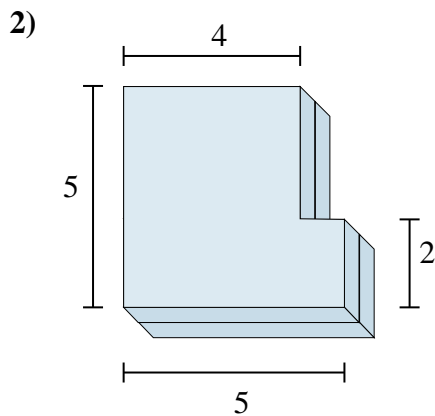
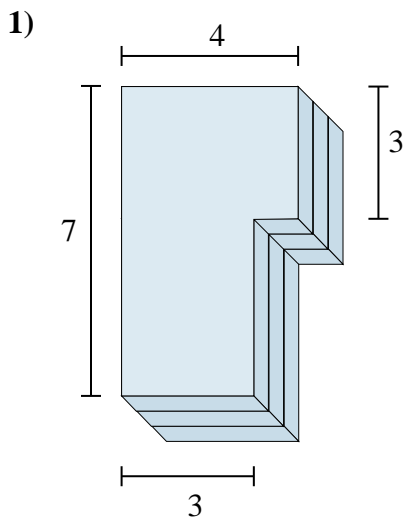

Risposte

1. _____
2. _____
3. _____
4. _____
5. _____
6. _____



Trova il volume totale di ogni figura.

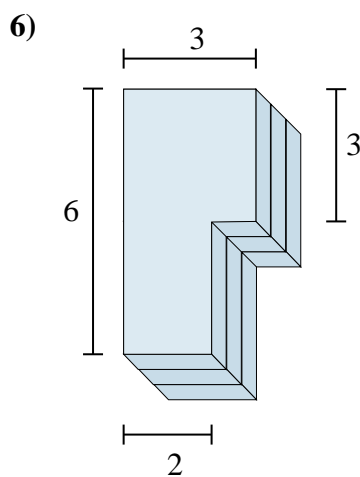
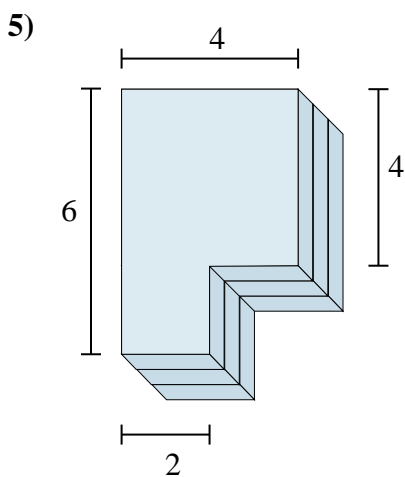
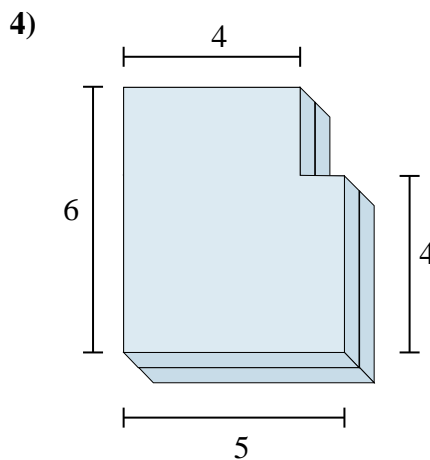
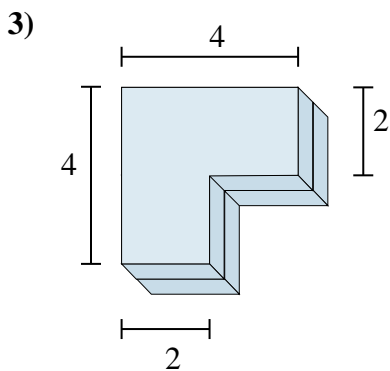
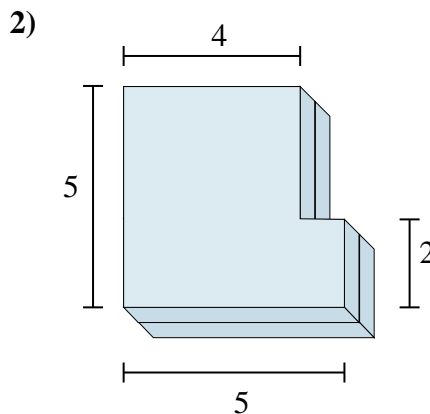
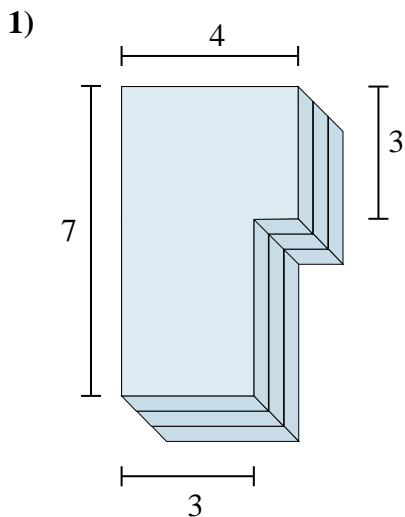

Risposte

1. **72 cm³**
2. **44 cm³**
3. **24 cm³**
4. **56 cm³**
5. **60 cm³**
6. **45 cm³**



Trova il volume totale di ogni figura.

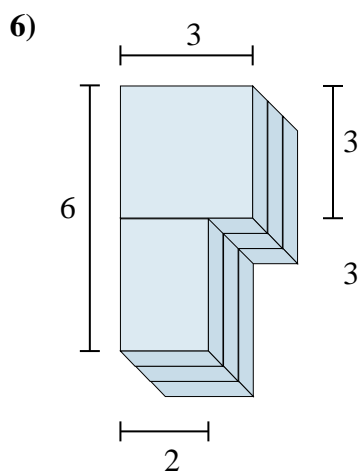
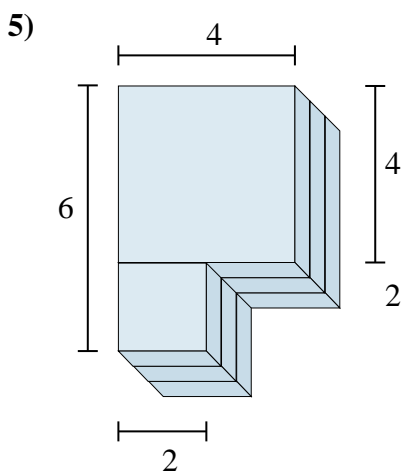
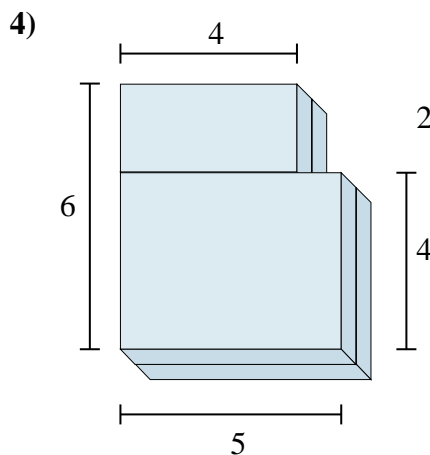
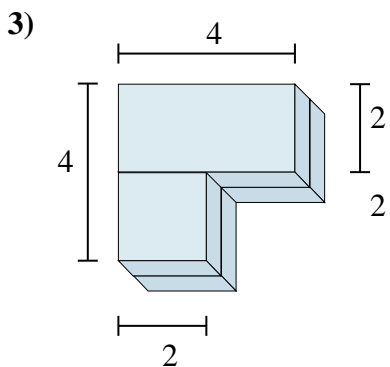
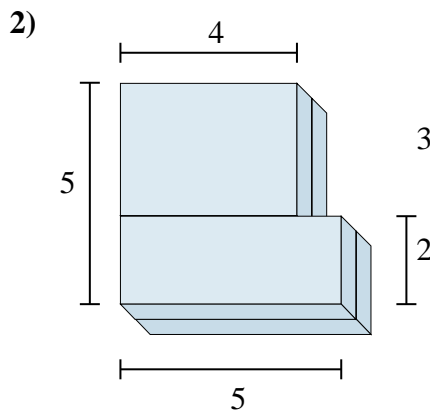
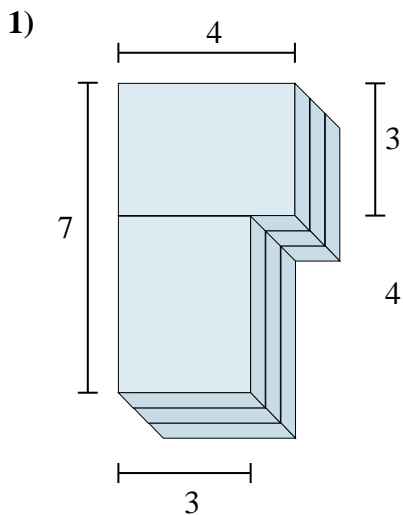

Risposte

- 1. _____
- 2. _____
- 3. _____
- 4. _____
- 5. _____
- 6. _____