

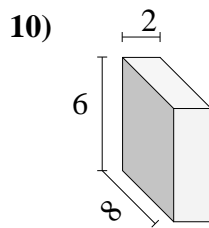

Trova il volume di ogni prisma.

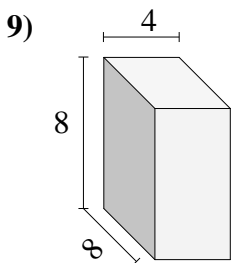
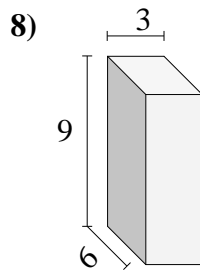
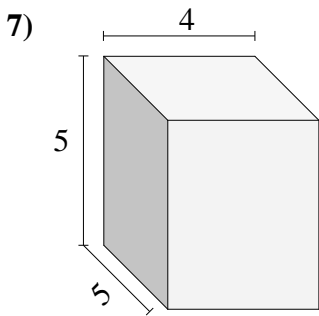
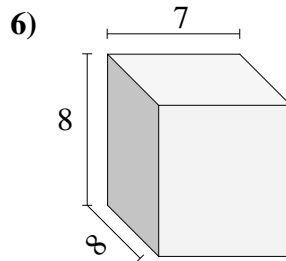
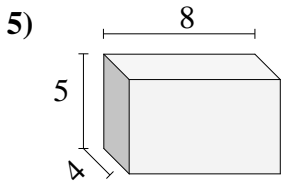
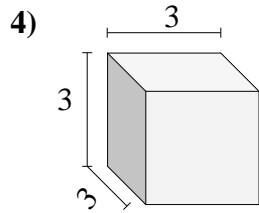
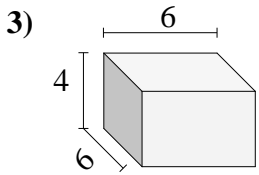
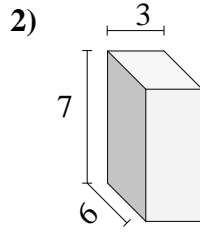
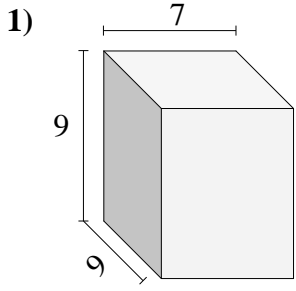

Risposte

- 1. _____
- 2. _____
- 3. _____
- 4. _____
- 5. _____
- 6. _____
- 7. _____
- 8. _____
- 9. _____
- 10. _____

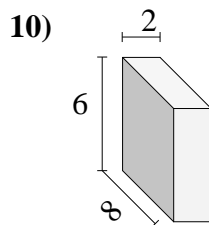
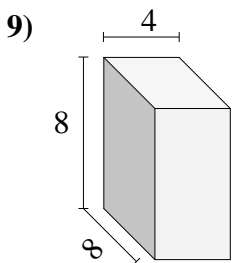
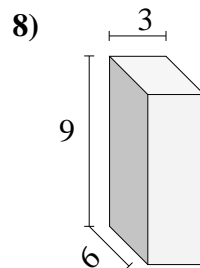
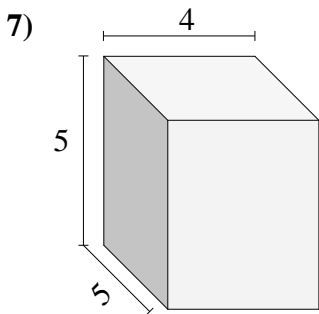
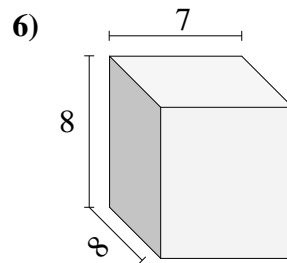
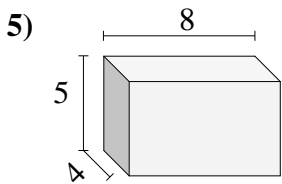
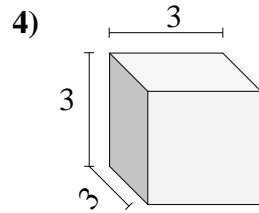
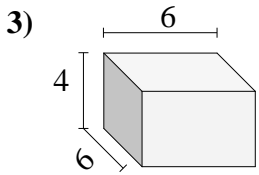
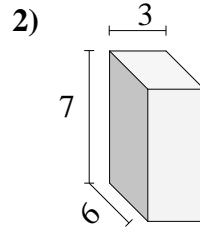
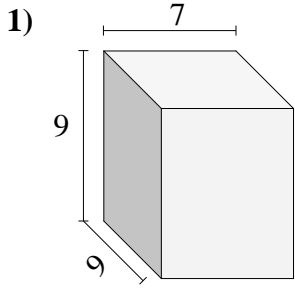

Trova il volume di ogni prisma.

**Risposte**1. **567 cm³**2. **126 cm³**3. **144 cm³**4. **27 cm³**5. **160 cm³**6. **448 cm³**7. **100 cm³**8. **162 cm³**9. **256 cm³**10. **96 cm³**