

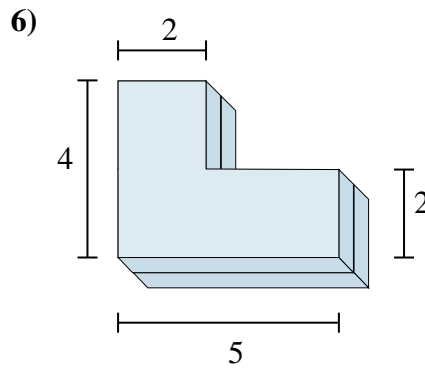

Trova il volume totale di ogni figura.

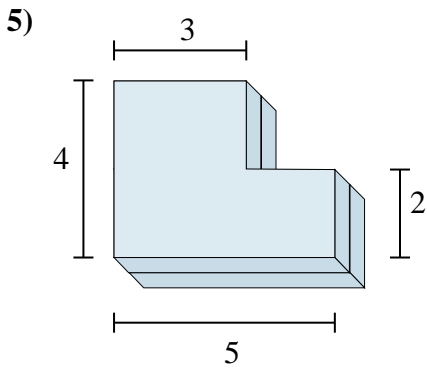
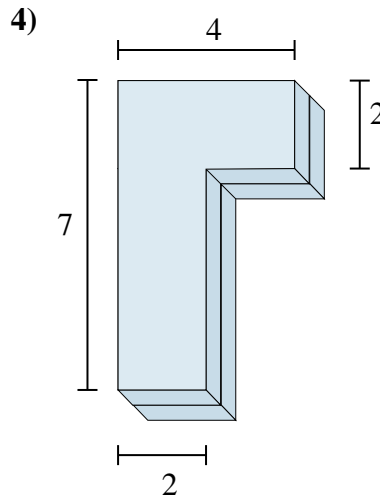
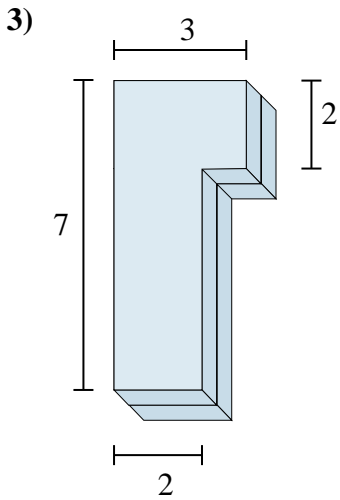
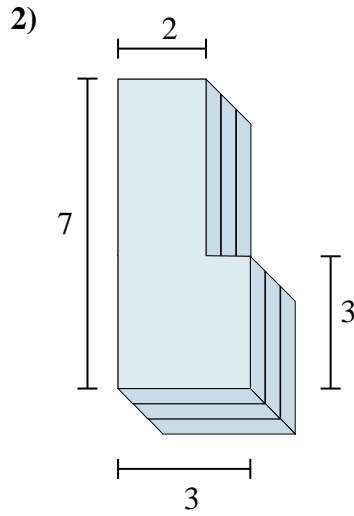
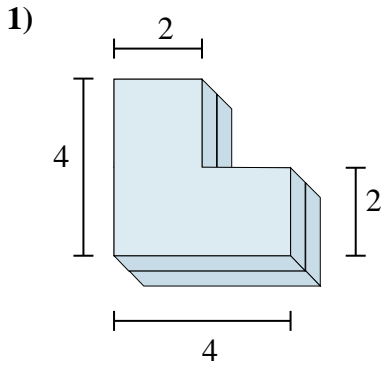

Risposte

1. _____
2. _____
3. _____
4. _____
5. _____
6. _____



Trova il volume totale di ogni figura.

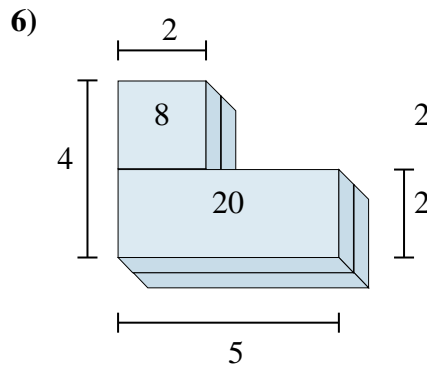
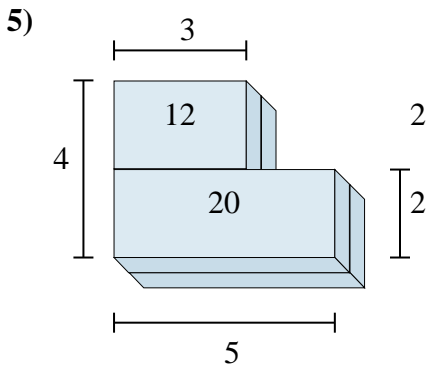
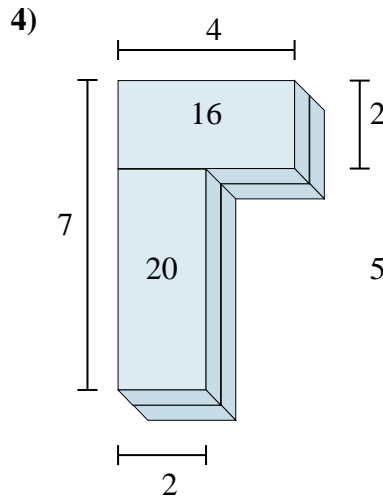
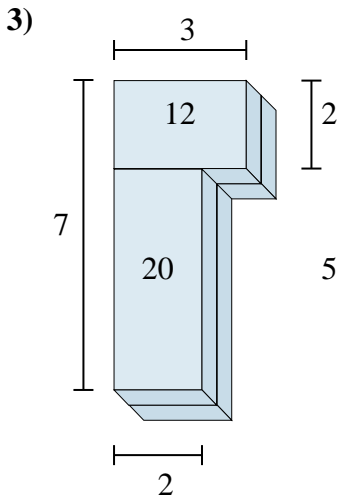
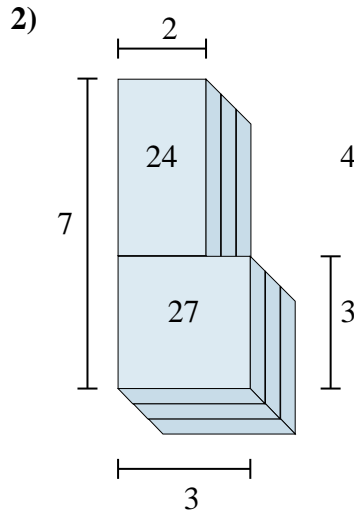
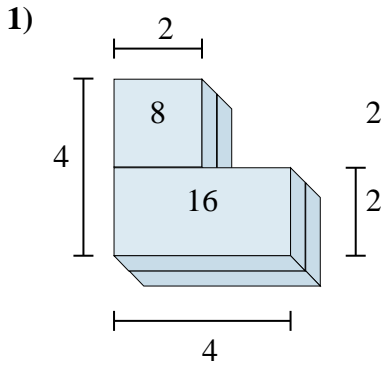

Risposte

1. 24 cm³
2. 51 cm³
3. 32 cm³
4. 36 cm³
5. 32 cm³
6. 28 cm³



Trova il volume totale di ogni figura.

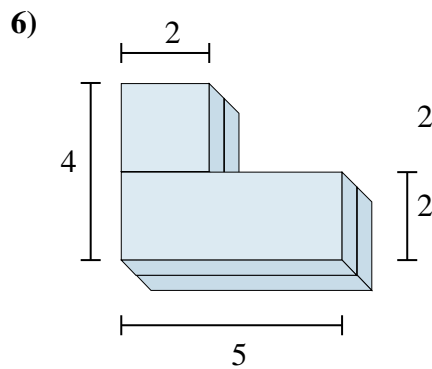
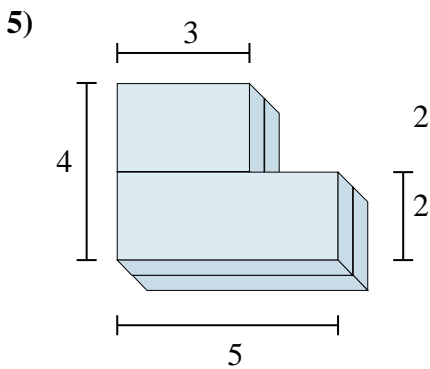
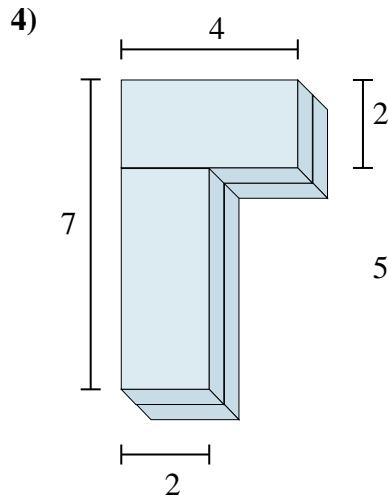
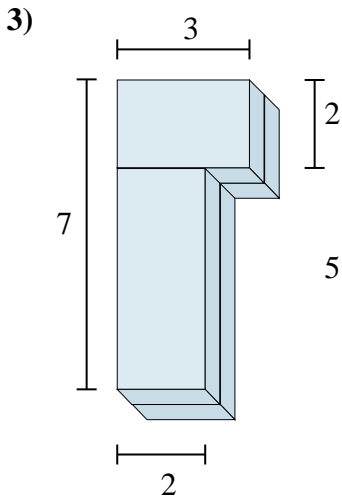
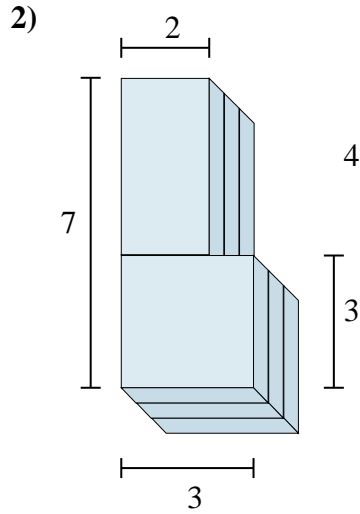
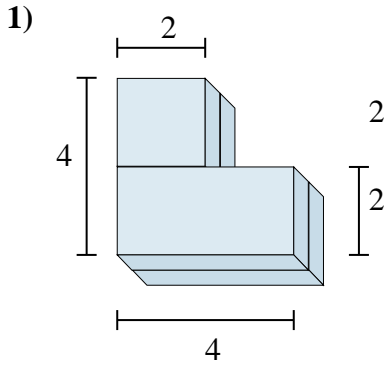

Risposte

1. _____
2. _____
3. _____
4. _____
5. _____
6. _____