

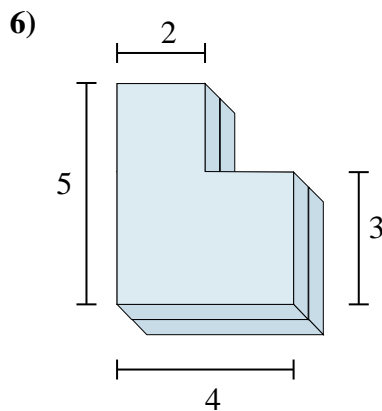

Trova il volume totale di ogni figura.

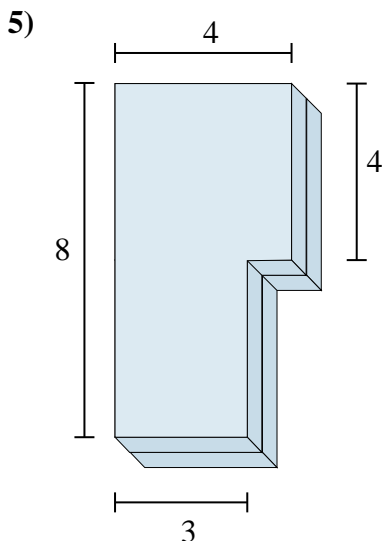
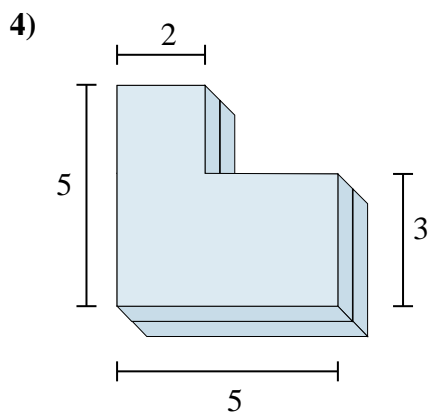
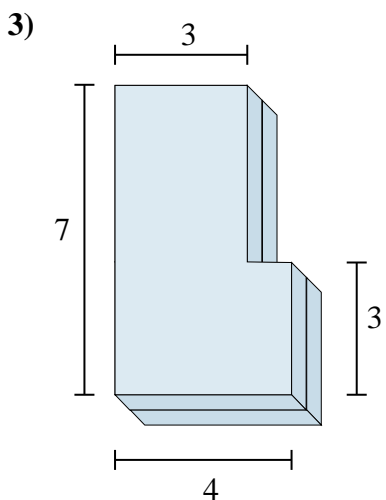
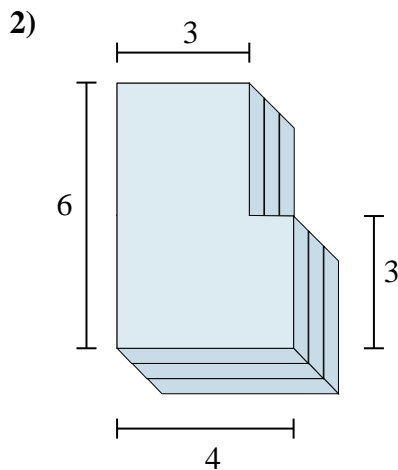
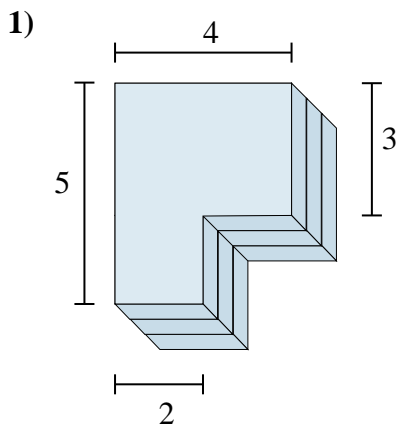

Risposte

1. _____

2. _____

3. _____

4. _____

5. _____

6. _____



Trova il volume totale di ogni figura.

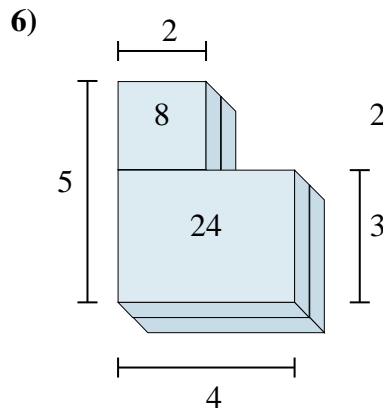
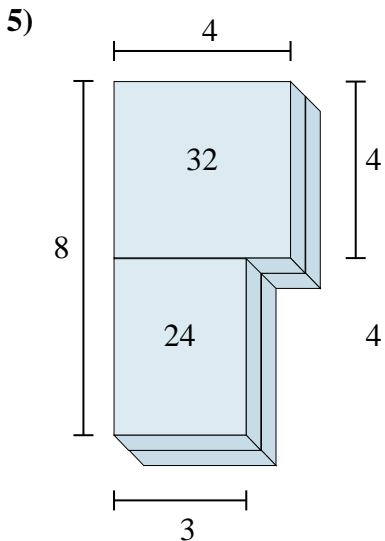
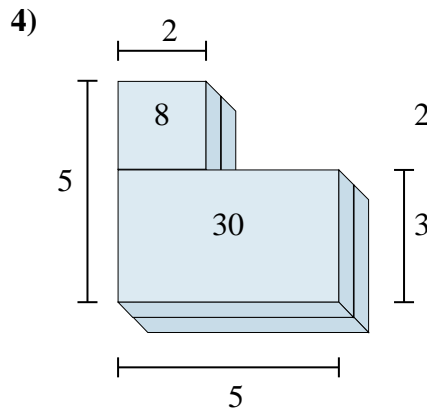
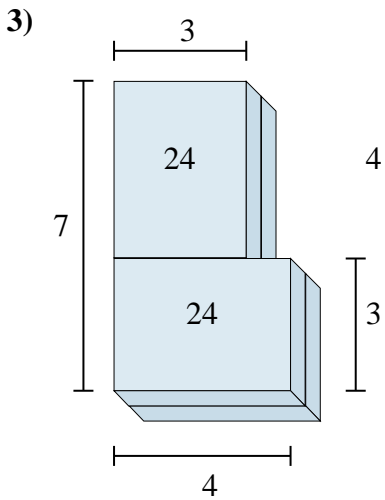
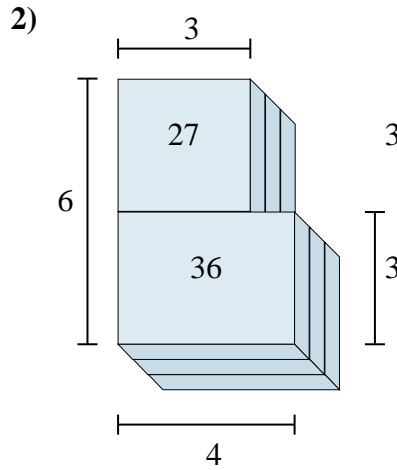
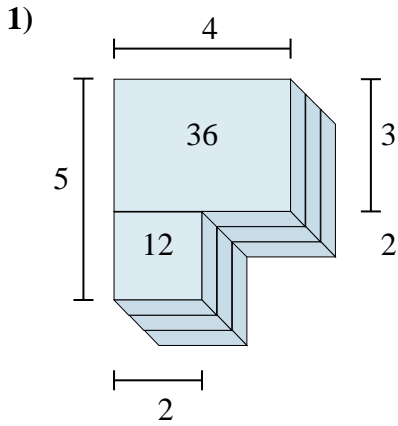

Risposte

1. 48cm³

2. 63cm³

3. 48cm³

4. 38cm³

5. 56cm³

6. 32cm³



Trova il volume totale di ogni figura.

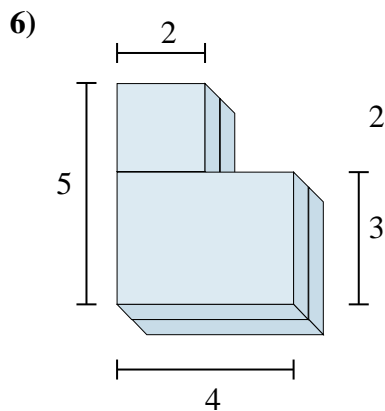
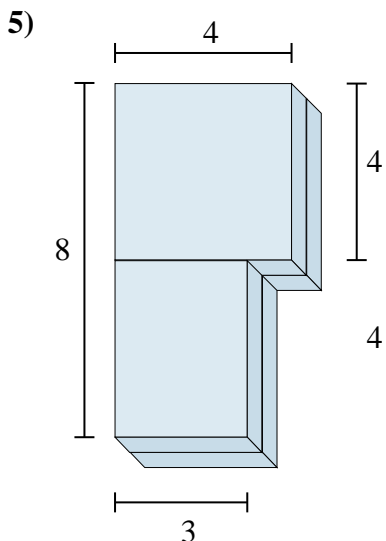
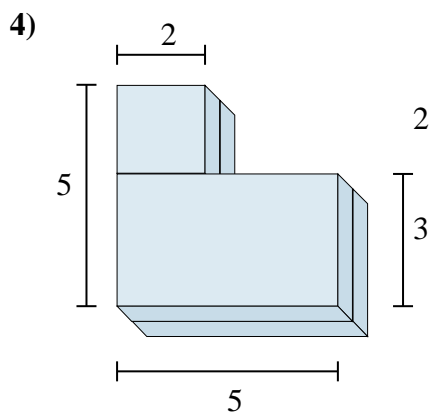
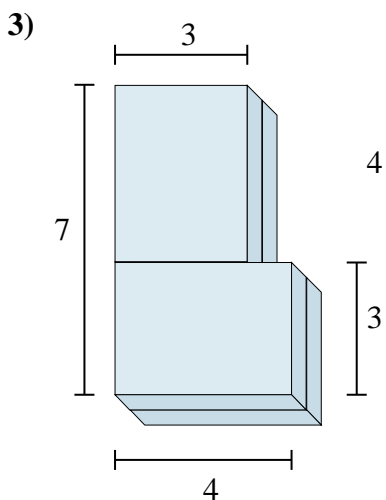
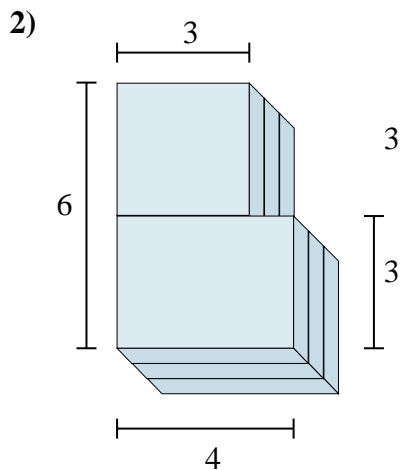
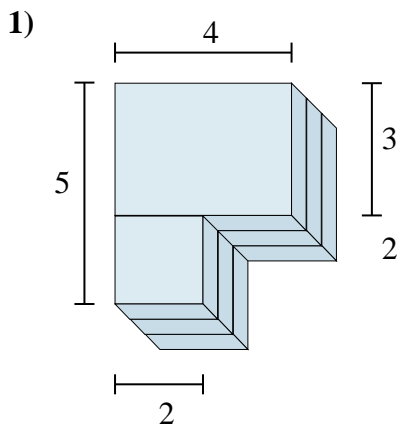

Risposte

1. _____

2. _____

3. _____

4. _____

5. _____

6. _____