

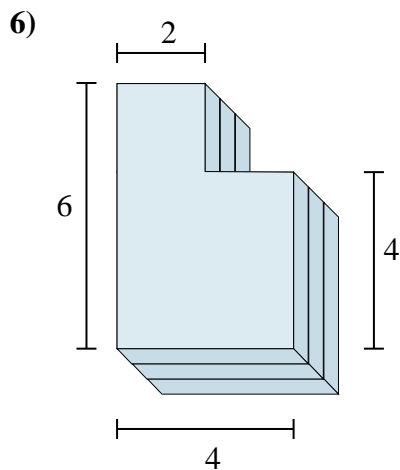

Trova il volume totale di ogni figura.

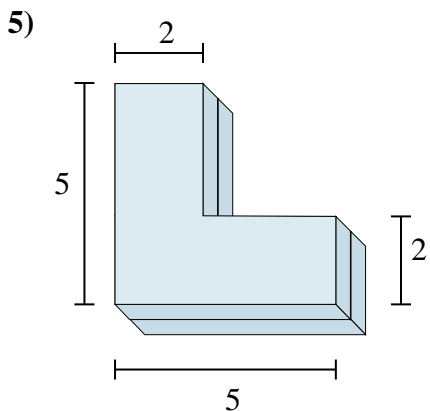
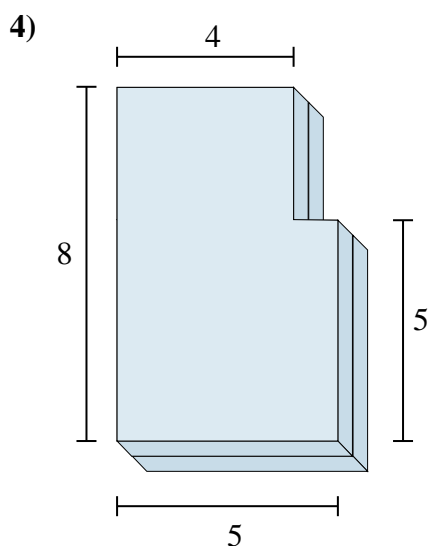
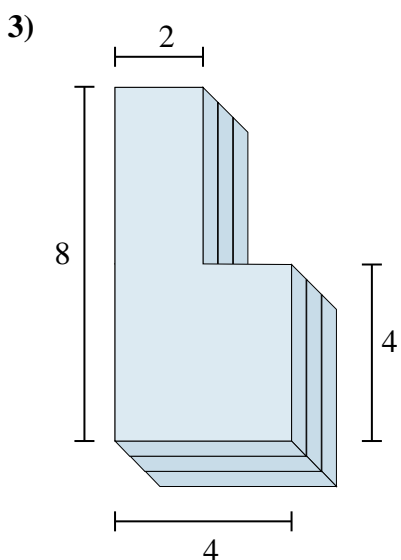
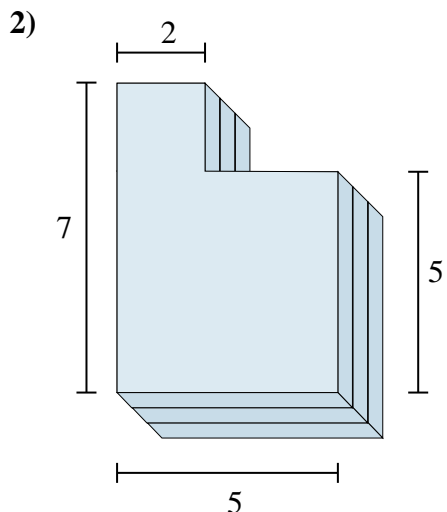
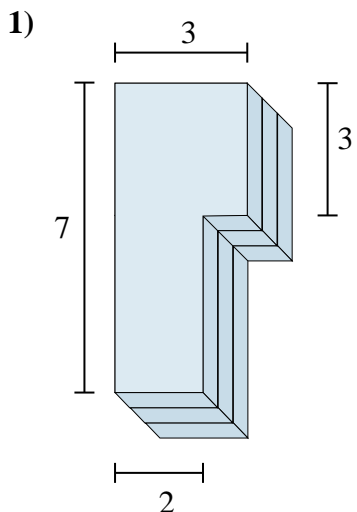

Risposte

1. _____

2. _____

3. _____

4. _____

5. _____

6. _____



Trova il volume totale di ogni figura.

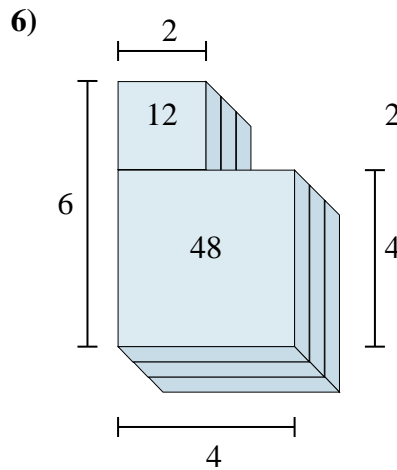
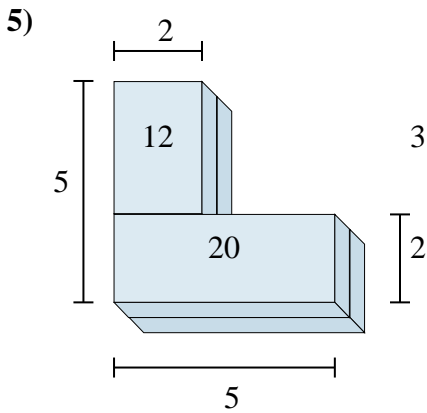
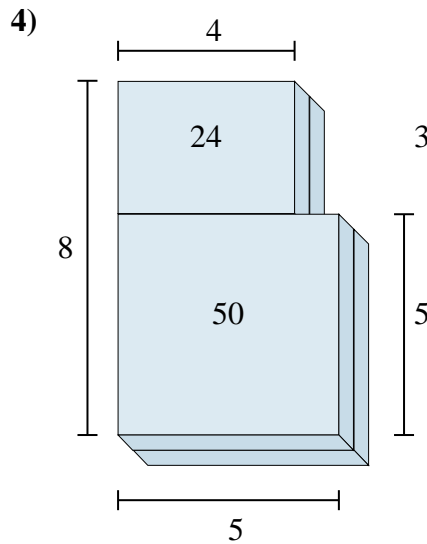
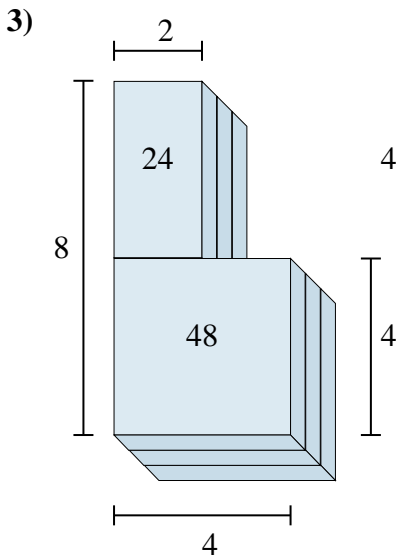
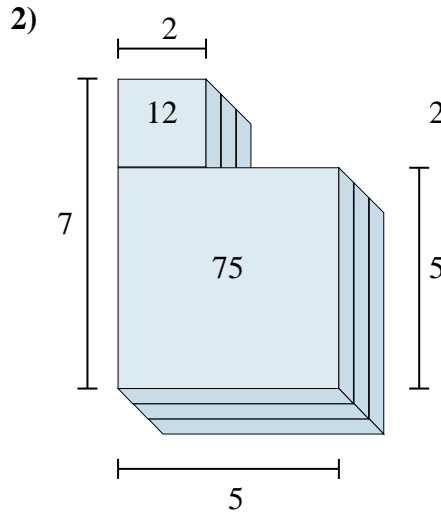
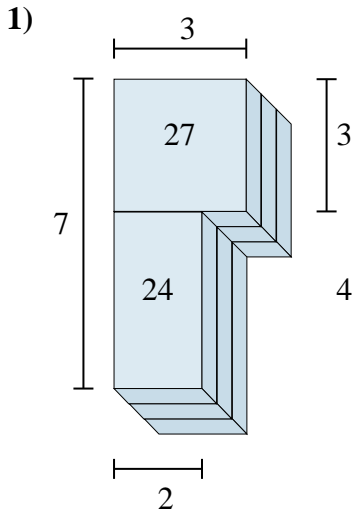

Risposte

1. 51cm³
2. 87cm³
3. 72cm³
4. 74cm³
5. 32cm³
6. 60cm³



Trova il volume totale di ogni figura.

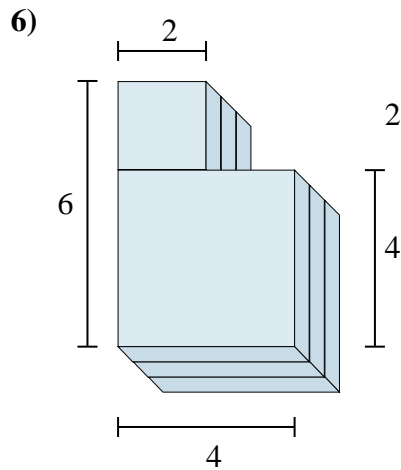
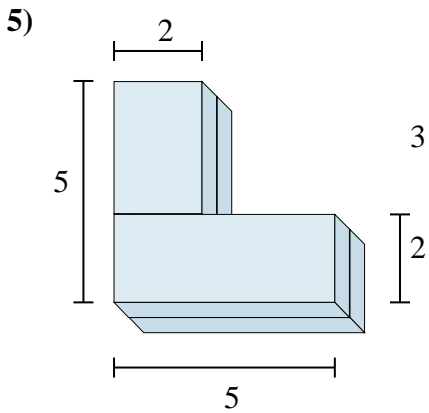
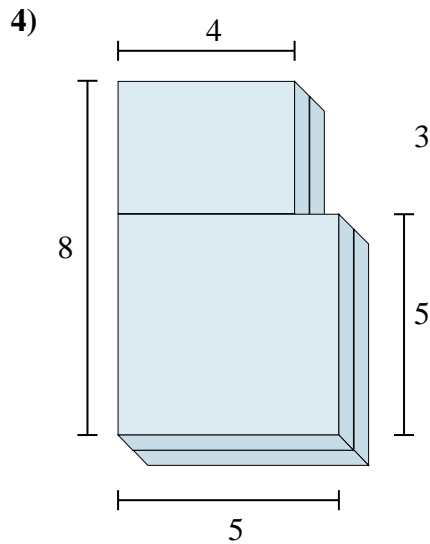
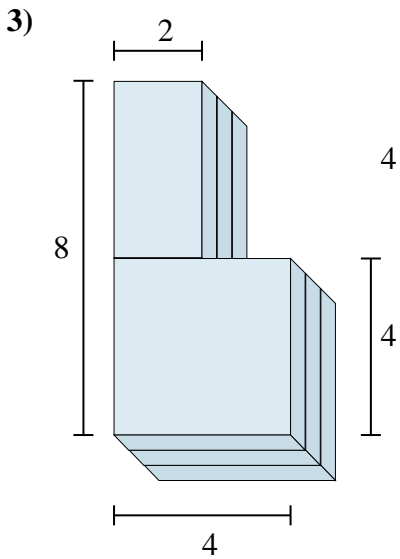
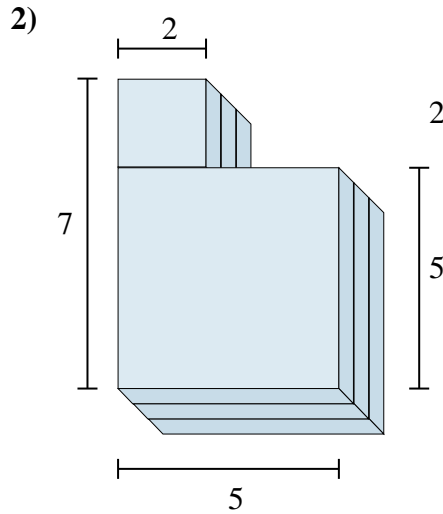
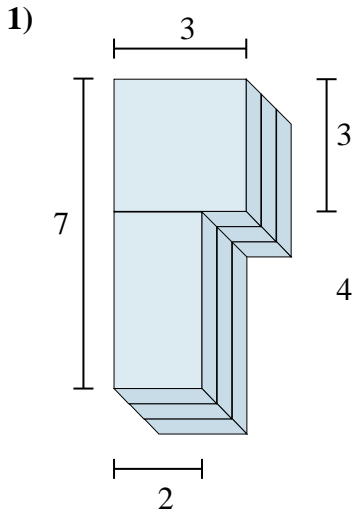

Risposte

1. _____

2. _____

3. _____

4. _____

5. _____

6. _____