

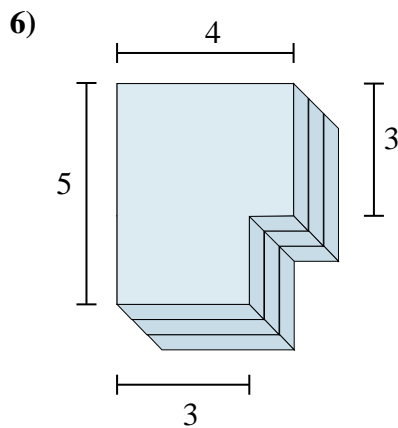

Trova il volume totale di ogni figura.

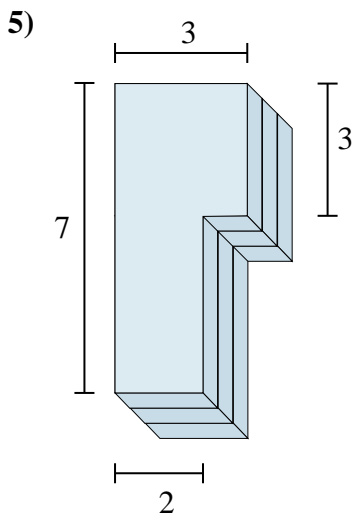
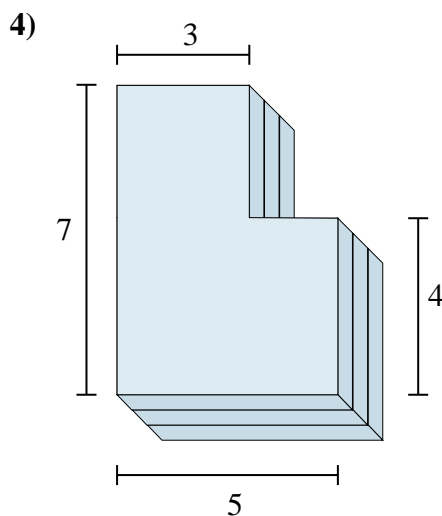
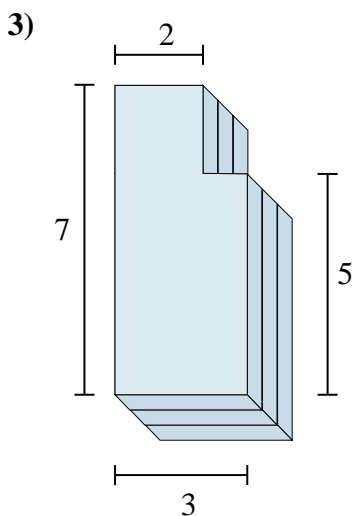
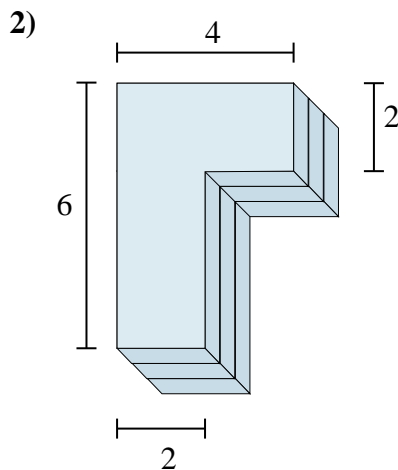
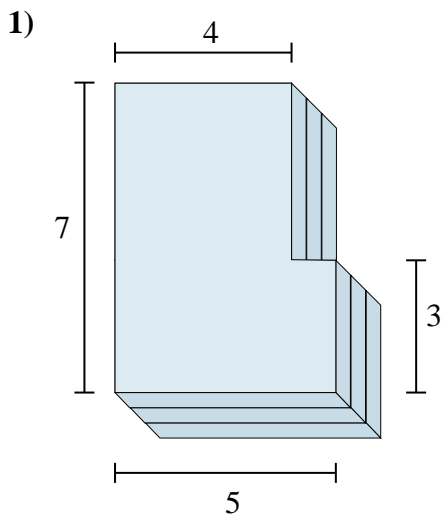

Risposte

1. _____

2. _____

3. _____

4. _____

5. _____

6. _____



Trova il volume totale di ogni figura.

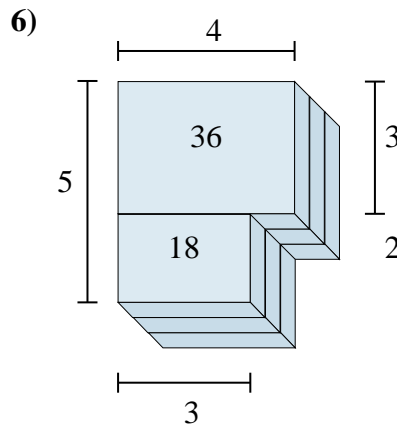
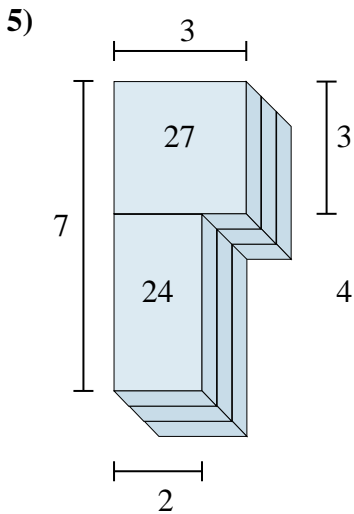
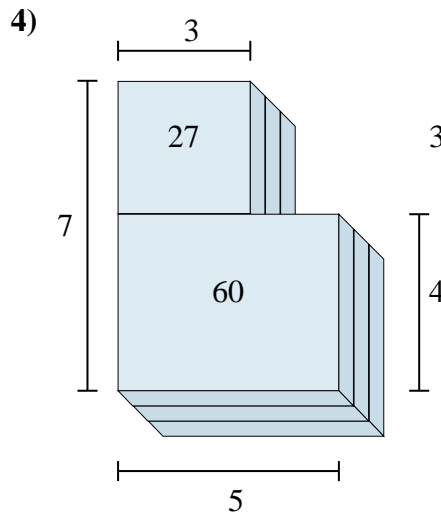
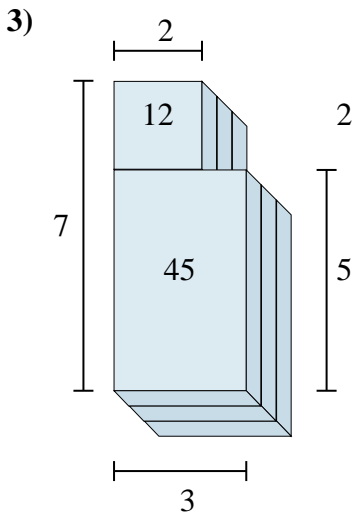
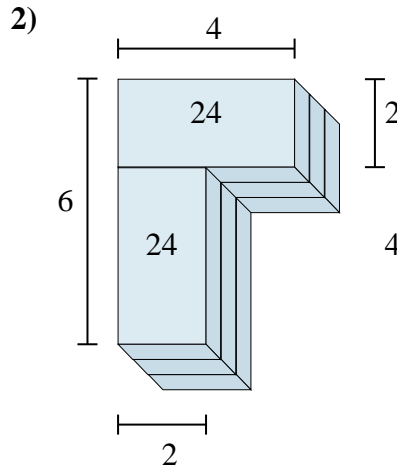
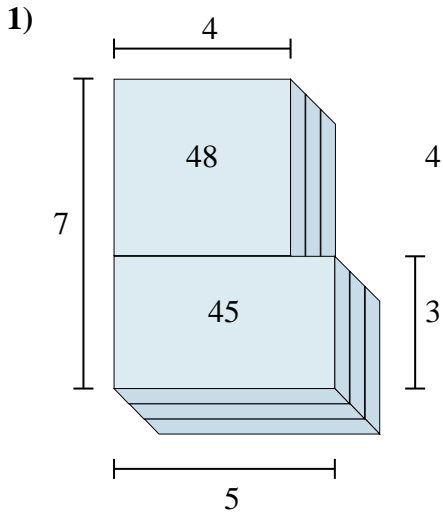

Risposte

1. 93cm³

2. 48cm³

3. 57cm³

4. 87cm³

5. 51cm³

6. 54cm³



Trova il volume totale di ogni figura.

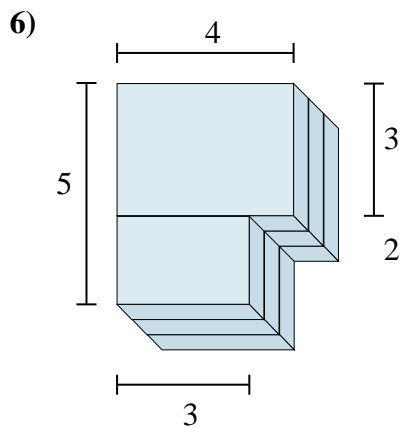
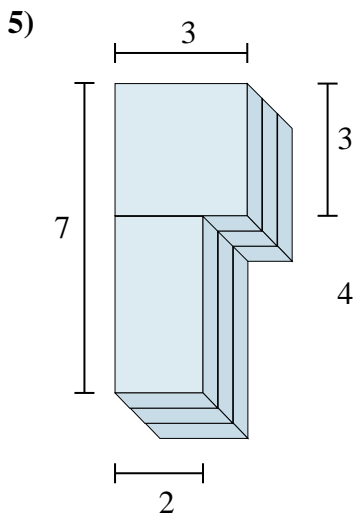
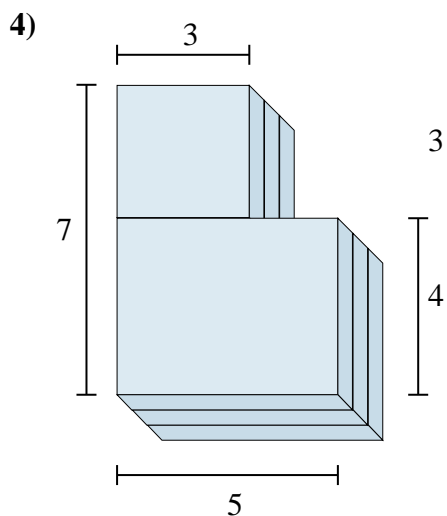
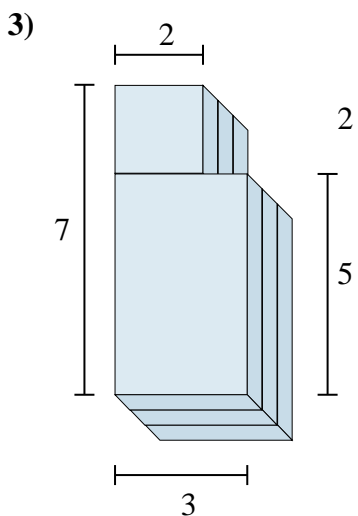
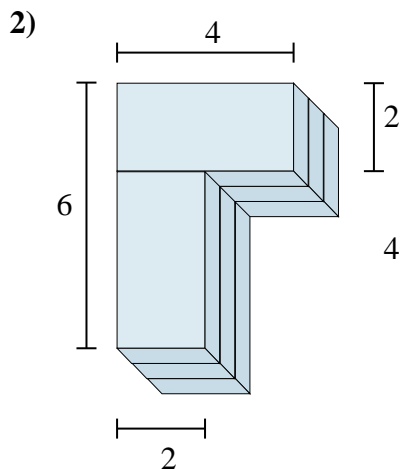
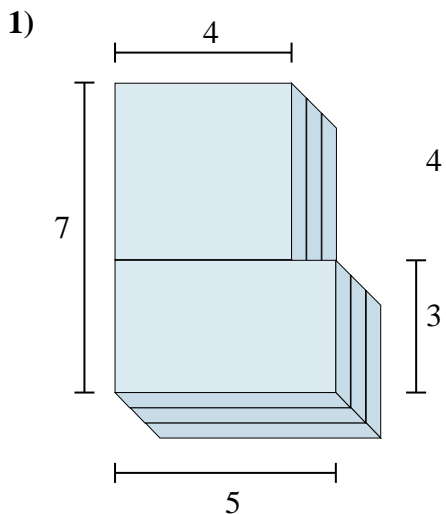

Risposte

1. _____

2. _____

3. _____

4. _____

5. _____

6. _____