

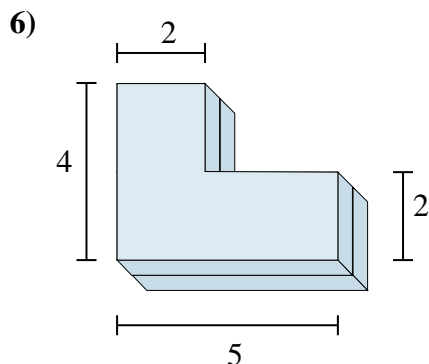

Trova il volume totale di ogni figura.

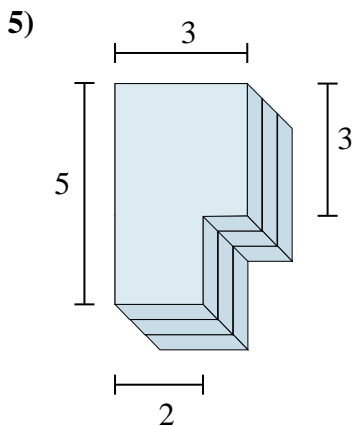
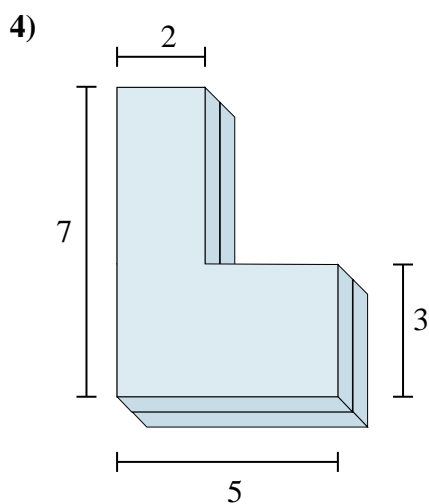
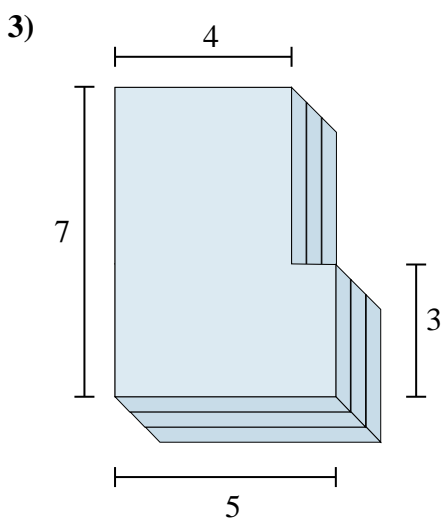
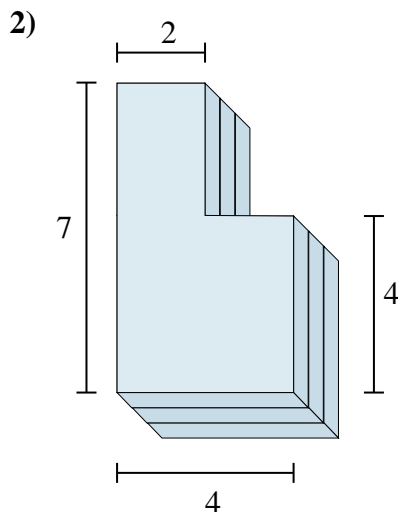
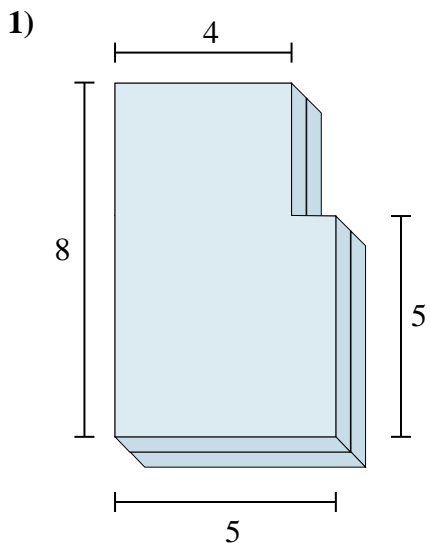

Risposte

1. _____

2. _____

3. _____

4. _____

5. _____

6. _____



Trova il volume totale di ogni figura.

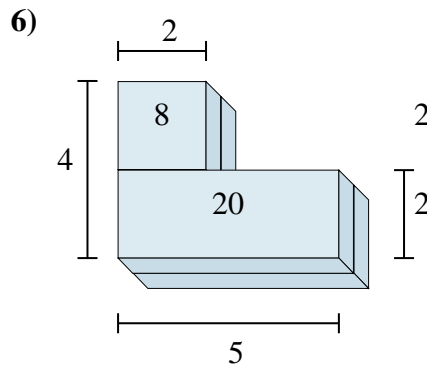
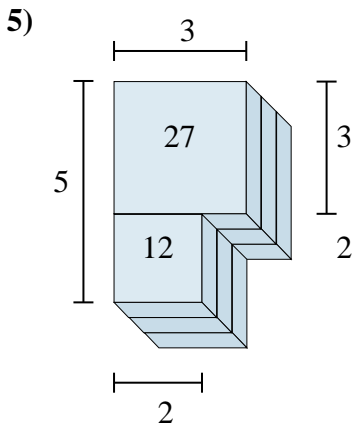
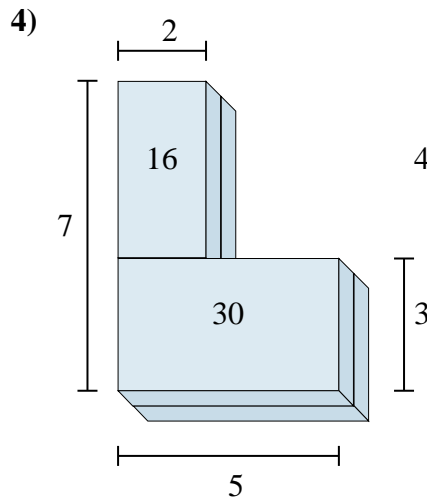
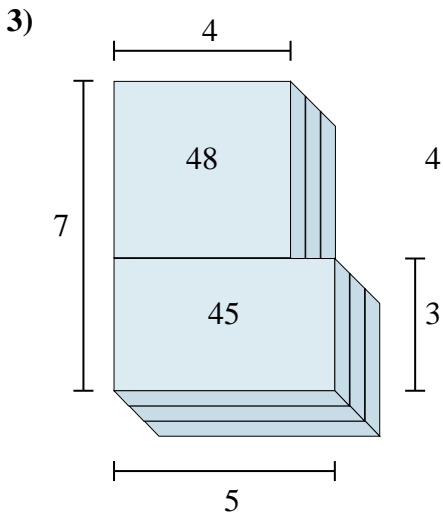
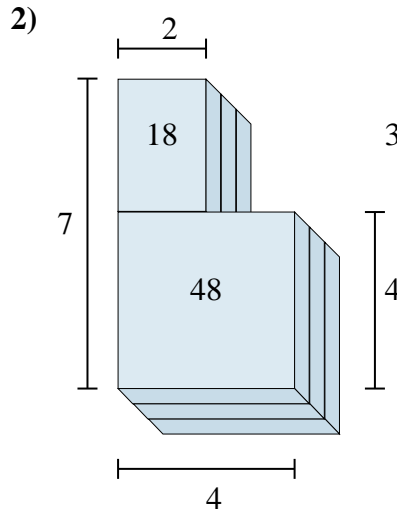
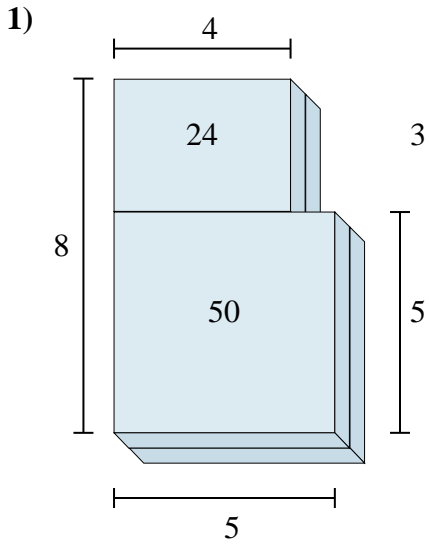

Risposte

1. 74cm³

2. 66cm³

3. 93cm³

4. 46cm³

5. 39cm³

6. 28cm³



Trova il volume totale di ogni figura.

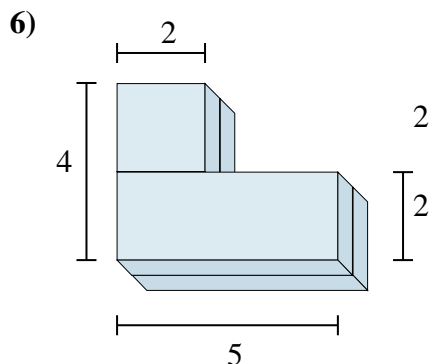
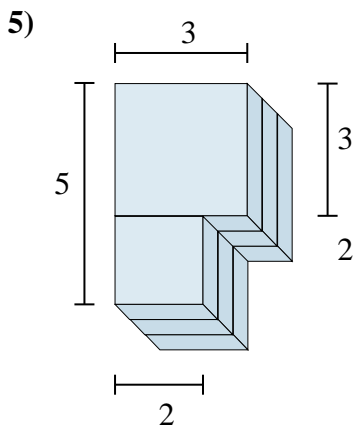
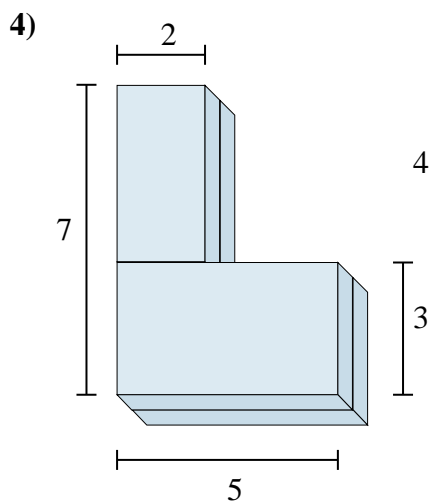
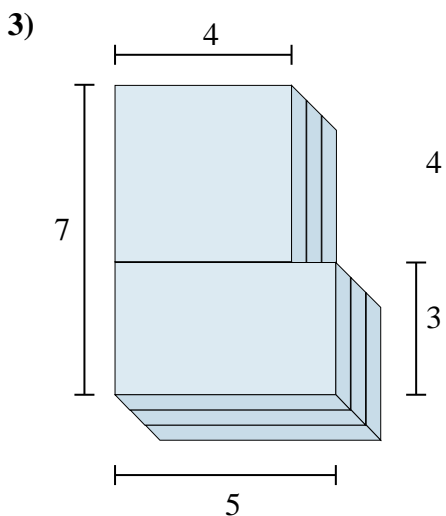
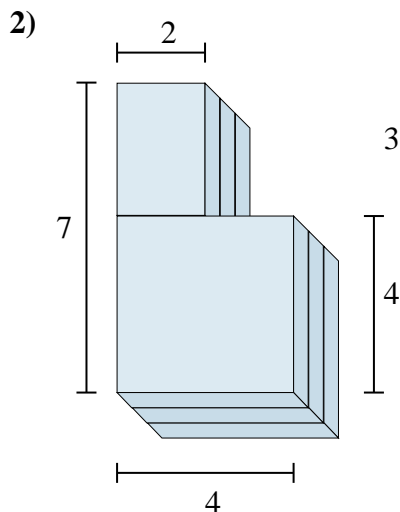
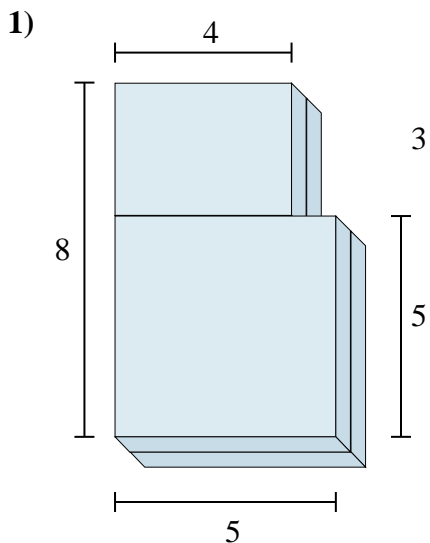

Risposte

1. _____

2. _____

3. _____

4. _____

5. _____

6. _____