

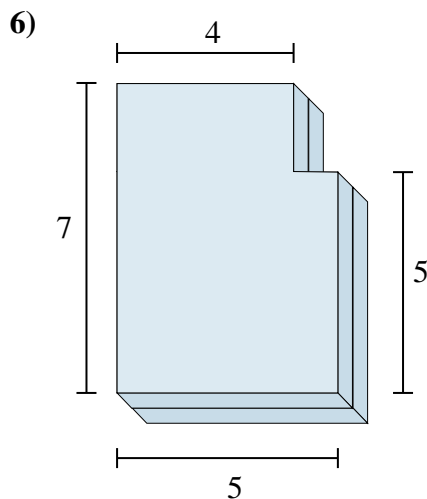

Trova il volume totale di ogni figura.

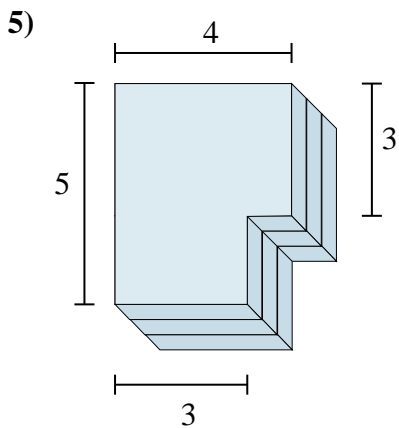
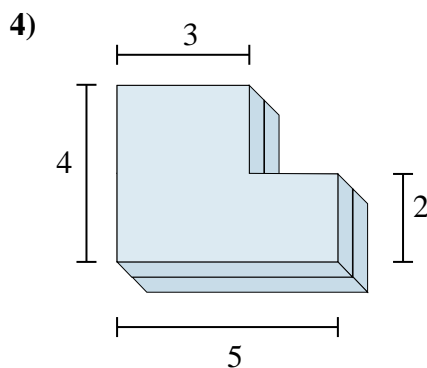
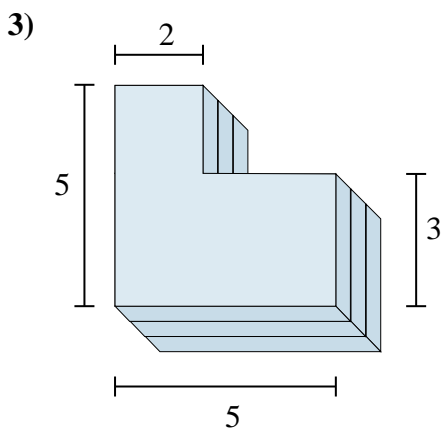
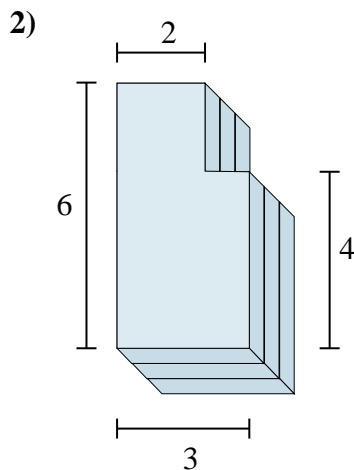
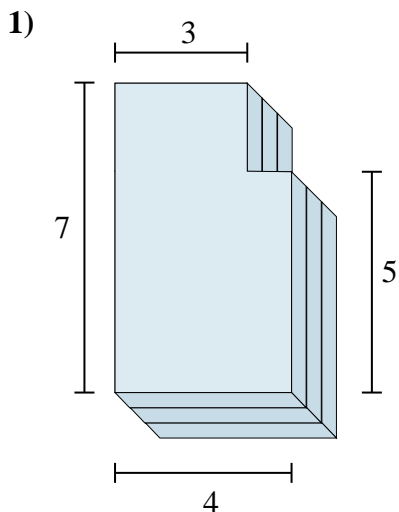

Risposte

1. _____

2. _____

3. _____

4. _____

5. _____

6. _____



Trova il volume totale di ogni figura.

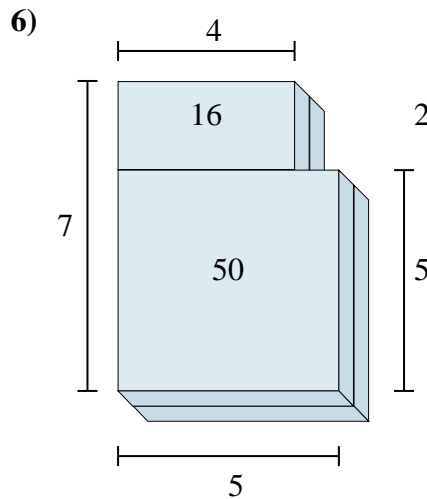
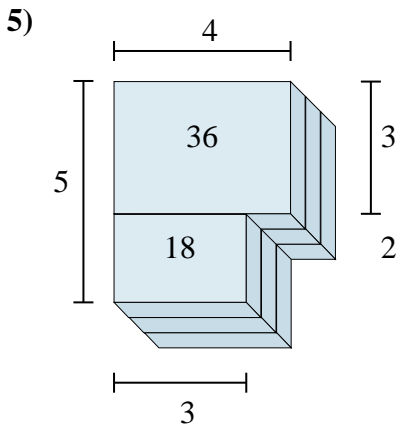
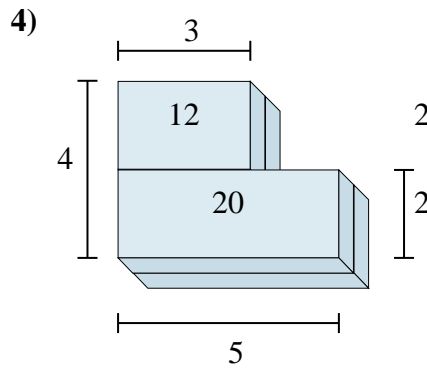
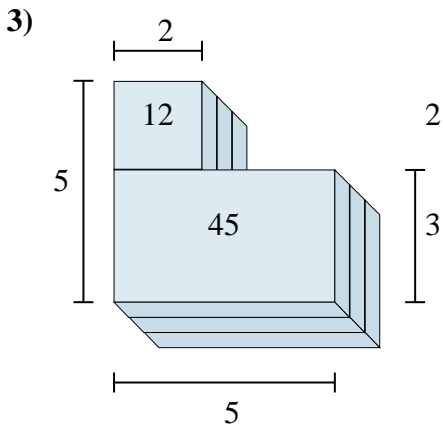
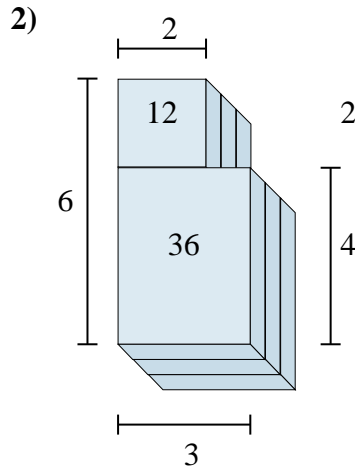
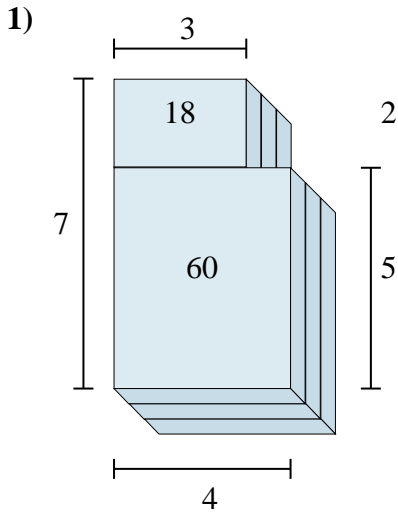

Risposte

1. 78cm³

2. 48cm³

3. 57cm³

4. 32cm³

5. 54cm³

6. 66cm³



Trova il volume totale di ogni figura.

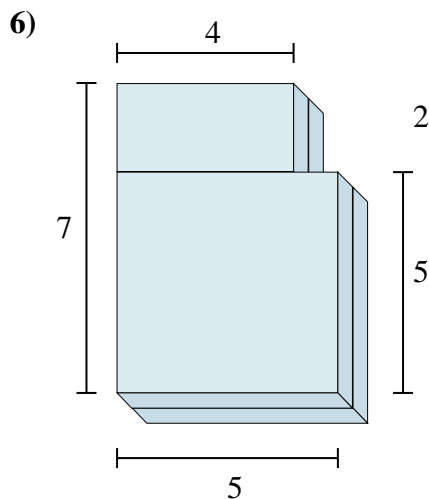
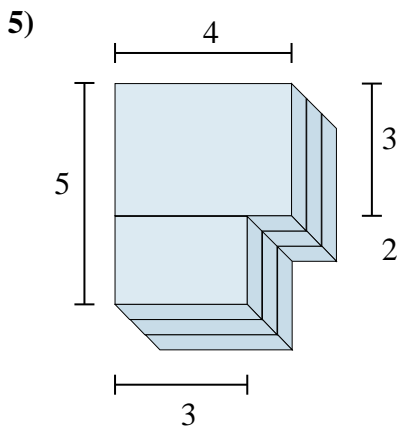
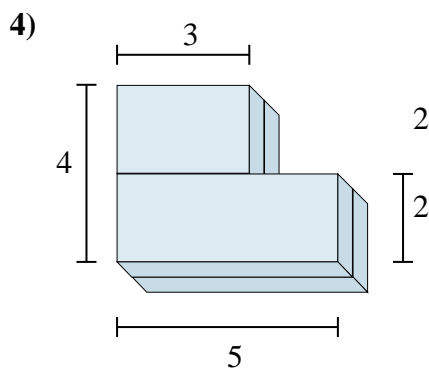
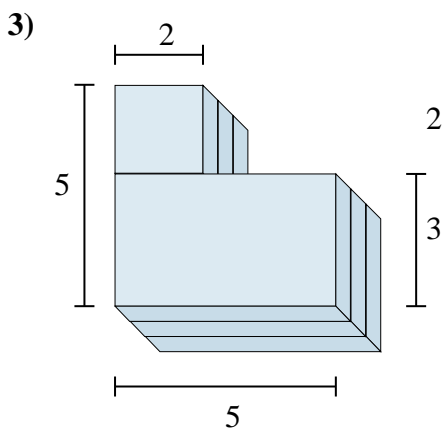
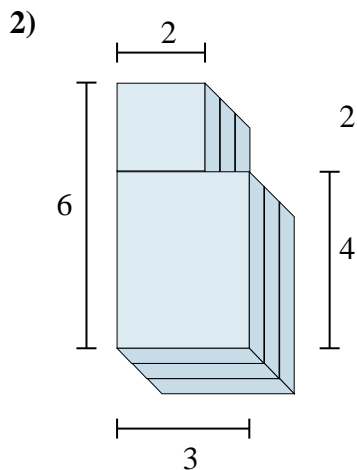
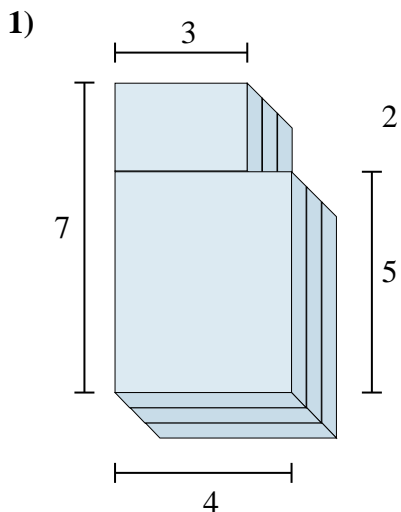

Risposte

1. _____

2. _____

3. _____

4. _____

5. _____

6. _____